

ModulCutD'Andrea

Turning tools

Drehenwerkzeuge

Utensilios para
torneado

Outils de
tournage

Utensili di
tornitura



Index
 Inhaltsverzeichnis
 Índice
 Index
 Indice

ModulCutD'Andrea

Turning tools

Drehenwerkzeuge

Utensilios para
 torneado

Outils de
 tournage

Utensili di
 tornitura

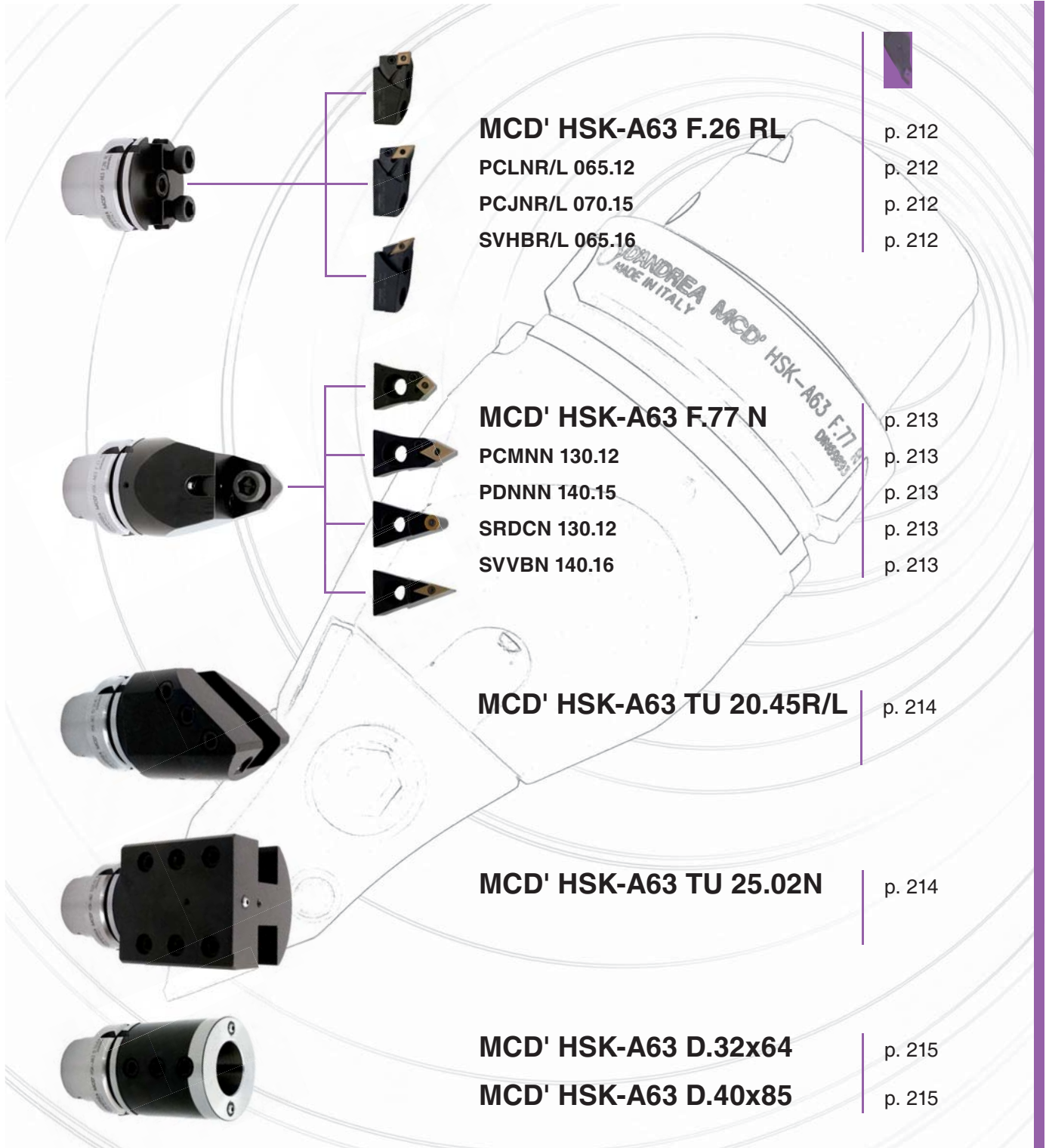

Turning tools

Drehenwerkzeuge

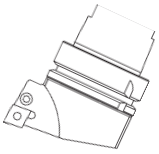

**MCD' HSK-A63 F.26
PCLNR/L 065.12**

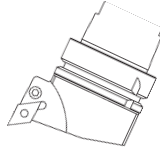

**MCD' HSK-A63 F.26
PDJNR/L 070.15**

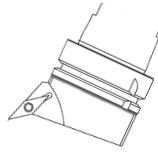

**MCD' HSK-A63 F.26
SVHBR/L 065.16**

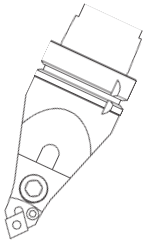

**MCD' HSK-A63F.77
PCMNN 130.12**

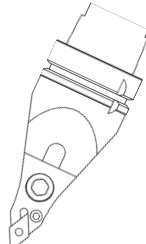

**MCD' HSK-A63F.77
PDNNN 140.15**

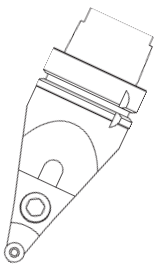

**MCD' HSK-A63 F.77
SRDCN 130.12**

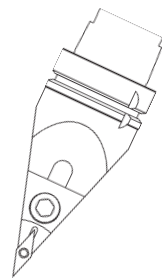

**MCD' HSK-A63 F.77
SVVBN 140.16**

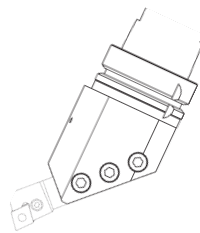

**MCD' HSK-A63
TU 20.45 R/L**

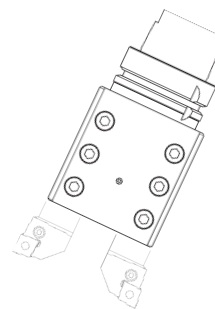

**MCD' HSK-A63
TU 25.02**

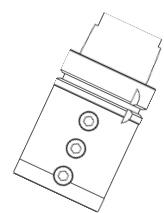

**MCD' HSK-A63 D.32
MCD' HSK-A63 D.40**

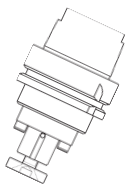

MONOd' PF

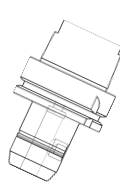

MONOd' WD

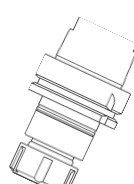

MONOd' ER

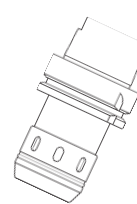

MONOforce 20 - 32

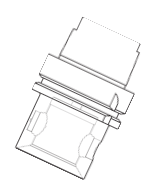

MHD' 50 - 63

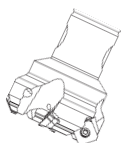

MHD' GRINTA

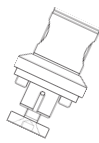

MHD' PF



MHD' WD



MHD' ER

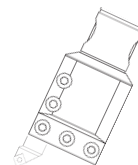

MHD' TU

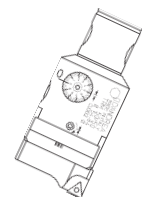

MHD' TRM

MCD' is the new line of tools and tool holders for lathes, built following HSK-A63 standards with constructive tolerance recommended **ICTM** for the application on spindles of MULTI-TASK machinery.

The **MCD'** is produced in modular versions, and is composed of tool holders with HSK coupling module and interchangeable bit holders.

The range is complete with tool holders which permit the mounting of tools for internal, external, cut and threading of the various standard programs on the market

MCD' ist eine neue Werkzeuglinie für Drehmaschinen mit MULTI TASK Spindelanbindung, gefertigt nach der Norm für HSK-A63 und den empfohlenen Konstruktionstoleranzen nach **ICTM**. Das **MCD'** Programm ist in Modularausführung hergestellt und besteht aus Werkzeughalterungen mit HSK Anschluss und austauschbaren Einsatzhalterungssitzen.

Die komplette Reihe von Werkzeughalterungen ermöglicht die der Werkzeugmontage für Innen, Außen, Abstech und Gewindebearbeitungen der verschiedenen, auf dem Markt erhältlichen Standardprogramme.

Utensilios para torneado

Outils de tournage

Utensili di tornitura

MCD' es la nueva línea de herramientas y porta-herramientas para torno, realizados conforme a las normas HSK-A63 con tolerancias de construcción **ICTM** recomendadas para la aplicación en mandriles de máquinas MULTI-TAREAS. El programa **MCD'** se produce en versión modular y está compuesto por porta-herramientas con acoplamiento HSK y asientos porta-inserto intercambiables. La gama presenta porta-herramientas que consienten el montaje de herramientas para el mecanizado interno, externo, corte y roscado de los diferentes programas estándar disponibles en el mercado.

MCD' est la nouvelle ligne d'outils et porte-outils pour le tour, réalisés selon les normes HSK-A63 avec des tolérances de fabrication **ICTM** recommandées pour l'application sur les mandrins de machines MULTI-TASK. Le programme **MCD'** est produit en version modulaire et il est composé de porte-outils avec attache HSK et logements porte plaquette interchangeables. La gamme est complétée avec le porte-outils permettant l'installation d'outils pour l'intérieur, l'extérieur, le découpage et filetage des différents programmes standards existants sur le marché.

MCD' è la nuova linea di utensili e portautensili da tornio, realizzati seguendo le norme HSK-A63 con tolleranze costruttive **ICTM** raccomandate per l'applicazione sui mandrini di macchine MULTI-TASK. Il programma **MCD'** è prodotto in versione modulare, ed è composto da portautensili con attacco HSK e seggi porta inserto intercambiabili. La gamma è completa di portautensili che permettono il montaggio di utensili per interni, esterni, taglio e filettatura dei vari programmi standard esistenti sul mercato.

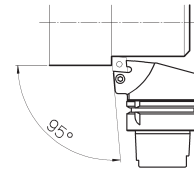

**MCD' HSK-A63 F.26
PCLNR/L 065.12**

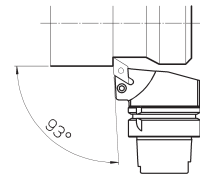

**MCD' HSK-A63 F.26
PDJNR/L 070.15**

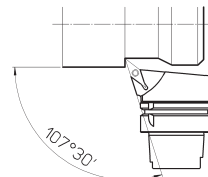

**MCD' HSK-A63 F.26
SVHBR/L 065.16**

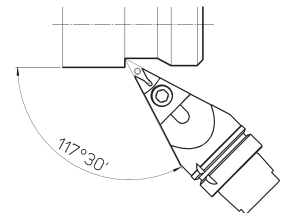

**MCD' HSK-A63 F.77
SVVBN 140.16**

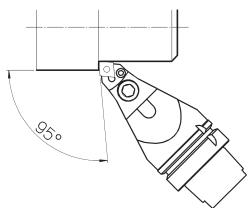

**MCD' HSK-A63 F.77
PCMNN 130.12**

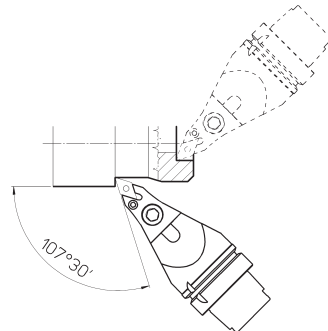

**MCD' HSK-A63 F.77
PDNNN 140.15**

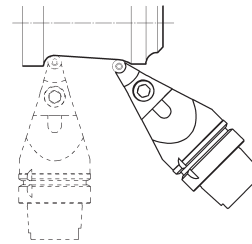

**MCD' HSK-A63 F.77
SRDCN 130.12**



Turning tools

Drehenwerkzeuge

Utensilios para torneado

Outils de tournage

Utensili di tornitura

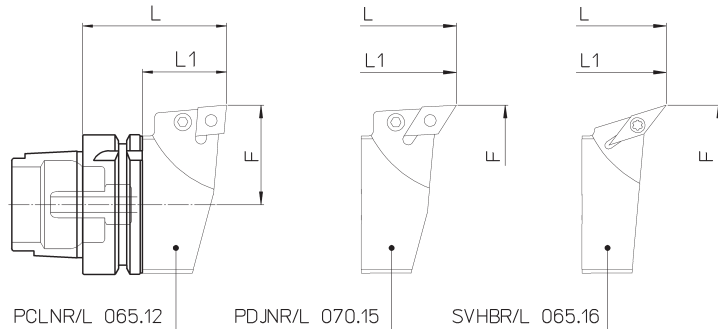

Supplied with coolant tube - Without bit-holders and clamping wrenches

Lieferung inklusive Kühlmittelrohr - Sitze und Anzugsschlüssel nicht inbegriffen

Completo con racor para el refrigerante - No incluye los asientos ni las llaves de apriete.

Pourvu de raccord pour liquide d'arrosage - Logements et vis de serrage exclus

Completo di raccordo per il refrigerante - Seggi e chiavi di serraggio esclusi

REF.	CODE	L	L ₁	F	kg	
MCD' HSK-A63 F.26 RL DIN69893	71HСКА63F026RL1	PCLNR/L 065.12	65	39	45	0.8
		PDJNR/L 070.15	70	44		
		SVHBR/L 065.16	65	39		

Turning bit-holders

Drehsitze

Asientos de torneado

Logements de tournage

Seggi di Tornitura

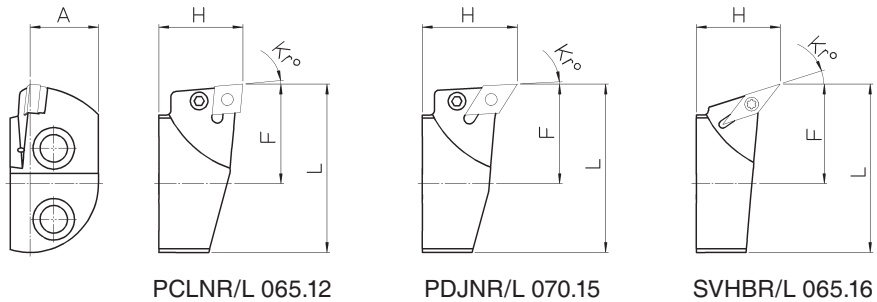

Right hand bit-holders shown

Rechte Plattenhalter abgebildet

Asientos derechos en la figura

Dans la figure les logements droites

In figura seggi destri

REF.	CODE	A	F	H	L	K _r ¹⁾	γ ²⁾	λ _s ³⁾				kg		
MCD' PCLNR 065.12	7501PCLNR065121	31	45	38	76	5°	6°	6°				0.4		
MCD' PCLNL 065.12	7501PCLNL065121													
MCD' PDJNR 070.15	7501PDJNR070151													
MCD' PDJNL 070.15	7501PDJNL070151													
MCD' SVHBR 065.16	7501SVHBR065161			38				17°30'	0°	0°				0.3
MCD' SVHBL 065.16	7501SVHBL065161													

1) Side cutting edge angle
2) True rake angle
3) Cutting edge inclination

1) Einstellungswinkel
2) Obere Freifläche
3) Neigungswinkel

1) Ángulo de registro
2) Ángulo de desmoldeo superior
3) Ángulo de inclinación

1) Angle d'enregistrement
2) Angle de dépouille supérieure
3) Angle d'inclinaison

1) Angolo di registrazione
2) Angolo di spoglia superiore
3) Angolo di inclinazione

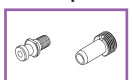

Turning tools
Drehenwerkzeuge
Utensilios para torneado
Outils de tournage
Utensili di tornitura

Supplied with coolant tube - Without bit-holders and clamping wrenches

Lieferung inklusive Kühlmittelrohr - Sitze und Anzugsschlüssel nicht inbegriffen

Completo con racor para el refrigerante - No incluye los asientos ni las llaves de apriete.

Pourvu de raccord pour liquide d'arrosage - Logements et vis de serrage exclus

Completo di raccordo per il refrigerante - Seggi e chiavi di serraggio esclusi

REF.	CODE	L	L1	kg	
MCD' HSK-A63 F.77 N DIN69893	71HСКА63F077N01	PCMNN 130.12	130	104	1.7
		PDNNN 140.15	140	114	
		SRDCN 130.12	130	104	
		SVVBN 140.16	140	114	

Turning bit-holders
Drehsitze
Asientos de torneado
Logements de tournage
Seggi di Tornitura

REF.	CODE	A	L	K _r ¹⁾	γ ²⁾	λ _s ³⁾				kg
MCD' PCMNN 130.12	7505PCMNN130121	31	53	50°	6°	0°	CNM..1204..	-	-	0.2
MCD' PDNNN 140.15	7505PDNNN140151		63	62°30'						
MCD' SRDCN 130.12	7505SRDCN130121		53	-	RCM..1204..	DMC US63	TORX 15			
MCD' SVVBN 140.16	7505SVVBN140161		63	72°30'				VBM..1604..		

- 1) Side cutting edge angle
- 2) True rake angle
- 3) Cutting edge inclination

- 1) Einstellungswinkel
- 2) Obere Freifläche
- 3) Neigungswinkel

- 1) Ángulo de registro
- 2) Ángulo de desmoldeo superior
- 3) Ángulo de inclinación

- 1) Angle d'enregistrement
- 2) Angle de dépouille supérieure
- 3) Angle d'inclinaison

- 1) Angolo di registrazione
- 2) Angolo di spoglia superiore
- 3) Angolo di inclinazione

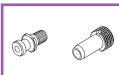

External turning
tool holders

Adapter für
Werkzeughalterungen

Adaptadores
porta-herramientas

Adapteurs porte
outils

Adattatori
Portautensili

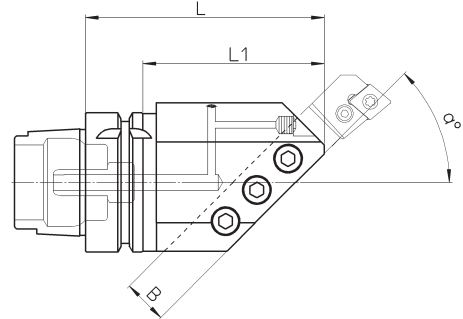
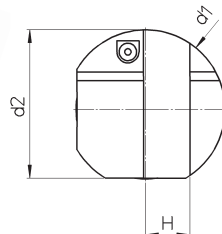

Right hand tool holder
shown

Adapter für
Drehklemmhalter

Adaptadores
porta-herramientas

Adapteurs porte
outils

In figura portautensile
destro

Supplied with
coolant tube -
Without bit-holders
and clamping wrenches

Lieferung inklusive
Kühlmittelrohr -
Werkzeuge und
Anzugsschlüssel nicht
inbegriffen

Completo con racor
para el refrigerante -
No incluye los asientos
ni las llaves de apriete.

Pourvu de raccord pour
liquide d'arrosage -
Logements et vis de
serrage excus

Completo di raccordo
per il refrigerante -
Seggi e chiavi di
serraggio esclusi

REF.	CODE	L	L ₁	d ₁	d ₂	a	BxH	kg
MCD' HSK-A63 TU20.45R DIN69893	71HСКА63T2045R1	108	82	72	67	45°	20x20	2.7
MCD' HSK-A63 TU20.45L DIN69893	71HСКА63T2045L1							

A standard application
requires left hand tools
with right hand adapters

Die normale Anwendung
erfordert ein linkes
Werkzeug in einem
rechten Adapter

El uso normal requiere
una herramienta
izquierda en una
adaptador derecho.

L'utilisation normale
nécessite un outil gauche
dans un adaptateur droit

L'utilizzo normale richiede
un utensile sinistro in un
adattatore destro

External turning
tool holders

Adapter für
Drehklemmhalter

Adaptadores
porta-herramientas

Adapteurs porte
outils

Adattatori
Portautensili

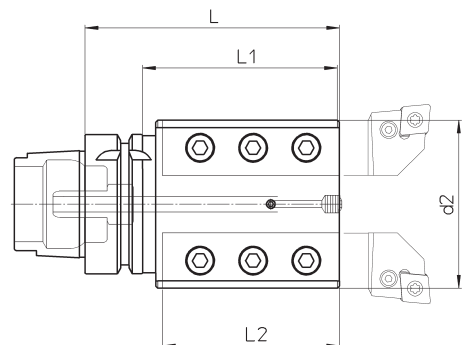
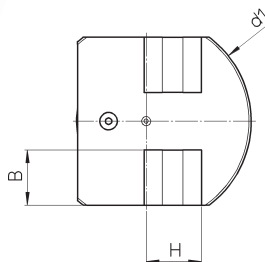

Supplied with
coolant tube -
Without bit-holders
and clamping wrenches

Lieferung inklusive
Kühlmittelrohr -
Werkzeuge und
Anzugsschlüssel nicht
inbegriffen

Completo con racor
para el refrigerante -
No incluye los asientos
ni las llaves de apriete.

Pourvu de raccord pour
liquide d'arrosage -
Logements et vis de
serrage excus

Completo di raccordo
per il refrigerante -
Seggi e chiavi di
serraggio esclusi

REF.	CODE	L	L ₁	L ₂	d ₁	d ₂	BxH	kg
MCD' HSK-A63 TU25.02N DIN69893	71HСКА63T2502N1	115	89	80	95	76	25x25	3.0

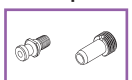

External turning
tool holders

Adapter für
Werkzeughalterungen

Adaptadores
porta-herramientas

Adapteurs porte
outils

Adattatori
Portautensili

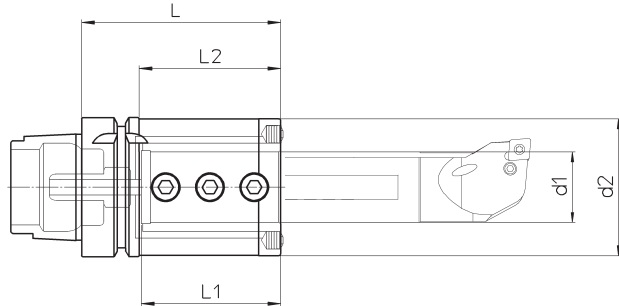

Supplied with
coolant tube -
Without bit-holders
and clamping wrenches

Lieferung inklusive
Kühlmittelrohr -
Sitze und
Anzugsschlüssel nicht
inbegriffen

Completo con racor
para el refrigerante -
No incluye los asientos
ni las llaves de apriete.

Pourvu de raccord pour
liquide d'arrosage -
Logements et vis de
serrage exclus

Completo di raccordo
per il refrigerante -
Seggi e chiavi di
serraggio esclusi

REF.	CODE	d_1^{H5}	d_2	L	L_1	L_2	kg
MCD' HSK-A63 D.32x64 DIN69893	71HKA63D326401	32	62	90	64	64	2.3
MCD' HSK-A63 D.40x85 DIN69893	71HKA63D408501	40	80	125	85	93	2.5

• Reduction bushes on
request

• Einsatzhülse auf
Anfrage

• Casquillos reductores
bajo pedido.

• Douilles de réduction
sur demande

• Bussole di riduzione a
richiesta

